

| 72012               | NS   | Sik | = | 🔊 |                     |                              |
|---------------------|--|-----|---|---|---------------------|------------------------------|
| 78012               |  |     | = | 🔊 | ~                   |                              |
| Pos. Nr.<br>Pos.no. | Beschreibung<br>Description  |     |   |   | Art.-Nr.<br>Art.no. | Preisgruppe<br>Price bracket |
| 1                   | Gehäuse kpl. Betr. Nr. 337<br>Body ass. complete Loco no. 337                    |     |   |   | 143925              | 31                           |
| 2                   | Führerhaus<br>Driver's cab   |     |   |   | 143926              | 24                           |
| 3                   | Stirnlampe<br>Front lamp   |     |   |   | 143927              | 5                            |
| 4                   | Lampenhalter<br>Lamp holder  |     |   |   | 143928              | 3                            |
| 5                   | Fenster L + R<br>Windows l + r   |     |   |   | 143929              | 6                            |
| 6                   | TS - Griffe<br>Part set - handles  |     |   |   | 143931              | 7                            |
| 7                   | Rauchfang + Lüftergitter<br>Chimnez + ventilator grills                          |     |   |   | 143932              | 5                            |
| 8                   | Griffe kurz + lang<br>Handles short + long                                       |     |   |   | 143933              | 7                            |
| 9                   | Vorbau<br>Front  |     |   |   | 143934              | 23                           |
| 10                  | Blinklicht<br>Blinking light   |     |   |   | 143935              | 5                            |
| 11                  | LED-Abdeckung<br>LED-Cover   |     |   |   | 143936              | 15                           |
| 12                  | Lautsprecher<br>Loudspeaker  |     |   |   | 129524              | 14                           |
| 13                  | Blinddeckel<br>Blind cover   |     |   |   | 143937              | 4                            |
| 14                  | Führerhausgewicht R+L<br>Driver's cab weight r+l                                 |     |   |   | 143938              | 11                           |
| 15                  | TS - Bremshebel<br>Part set - brake lever  |     |   |   | 143923              | 6                            |
| 16                  | Lampen L+R<br>Lamps l+r  |     |   |   | 143924              | 6                            |
| 17                  | TS - Lichtleiter+Linsen+Signal<br>Part set - light conductor+lenses+signal light |     |   |   | 143917              | 7                            |
| 18                  | TS - Holzlaufbrett+Sandkasten<br>Part set - wooden runway +sandbox               |     |   |   | 143918              | 9                            |
| 19                  | Sandkasten hinten L+R<br>Sandboxes rear l+r                                      |     |   |   | 143920              | 8                            |
| 20                  | Platine<br>PCB   |     |   |   | 143908              | 40                           |
| 21                  | GF-Schraube M1,6x3 mm<br>GF - screw  |     |   |   | 143760              | 4                            |
| 22                  | Griff Pufferbohle<br>Buffer beam handle  |     |   |   | 143930              | 6                            |

Änderungen in Konstruktion und Ausführung vorbehalten  
We reserve the right to change the construction and specification

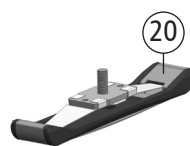
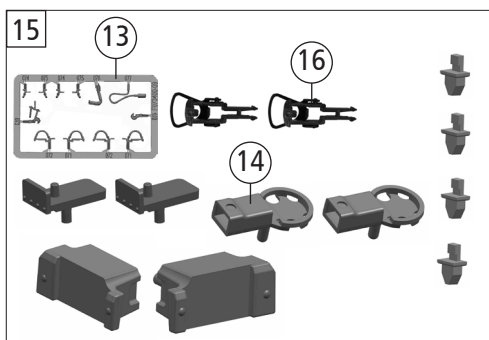
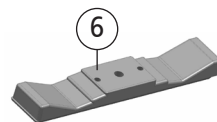
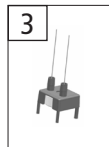
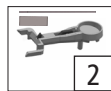
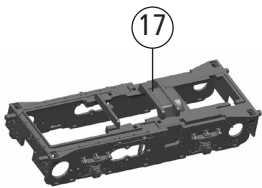
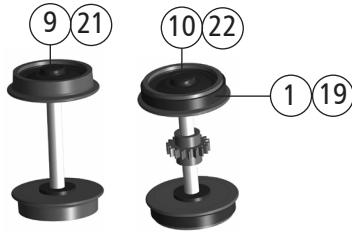
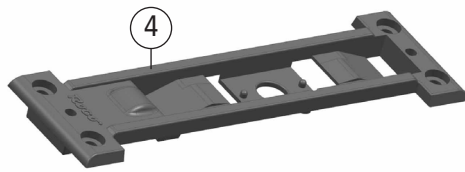
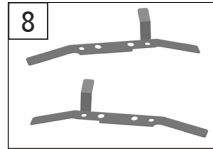
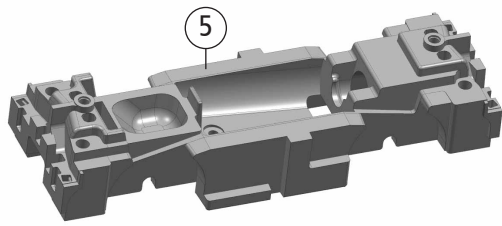

| 72012                    | NS  | Sik | =                   | 🔊                            |   |
|--------------------------|---|-----|---------------------|------------------------------|---|
| 78012                    |   |     | =                   | 🔊                            | ~ |
| Pos. Nr.<br>Pos.no.      | Beschreibung<br>Description   |     | Art.-Nr.<br>Art.no. | Preisgruppe<br>Price bracket |   |
| 1                        | Hafrings.10Stk.10,3 bis 12,8m<br>Traction tyres                                 |     | 40069               | ---                          |   |
| 2                        | TS - Digital Kupplung<br>Part set - digital coupling                            |     | 143911              | 11                           |   |
| 3                        | Spule kpl.<br>Spool complete  |     | 143912              | 13                           |   |
| 4                        | Lokboden<br>Loco chassis  |     | 143913              | 13                           |   |
| 5                        | Grundrahmen<br>Base frame   |     | 143914              | 13                           |   |
| 6                        | Schleifergewicht<br>Slider weight   |     | 143915              | 8                            |   |
| 7                        | Motor m. Schnecke<br>Motor with wormgear  |     | 143770              | 16                           |   |
| 8                        | Radkontakt L+R<br>Wheel contact l+r   |     | 143919              | 11                           |   |
| 9                        | Radsatz o. Zahnrad o. Haftring<br>Wheelset w/o gearwheel w/o tract. tyre        |     | 143909              | 10                           |   |
| 10                       | Radsatz m. Zahnrad m. 2 Haftringe<br>Wheelset w. gearwheel w. 2 tract. tyres    |     | 143910              | 12                           |   |
| 11                       | Puffer flach<br>Buffer flat   |     | 143921              | 3                            |   |
| 12                       | Puffer gewölbt<br>Buffer curved   |     | 143922              | 3                            |   |
| 13                       | TS - Bremschläuche + Zughaken<br>Part set of brake tubes & coupling hooks       |     | 139832              | 7                            |   |
| 14                       | Kupplungskammer<br>Coupling reception   |     | 143939              | 4                            |   |
| 15                       | Zurüstbeutel<br>Bag of accesories   |     | 144001              | 16                           |   |
| 16                       | Standardkupplung<br>Standard coupling   |     | 89246               | 6                            |   |
| 17                       | Blende<br>Bogie   |     | 143916              | 22                           |   |
| 18                       | GF-Schraube M1,6x16 mm<br>GF - screw  |     | 143761              | 4                            |   |
| <b>AC - Wechselstrom</b> |   |     |                     |                              |   |
| 19                       | Haftreifen<br>Traction tyres  |     | 00544007            | 1                            |   |
| 20                       | Schleifer<br>Slider   |     | 86030               | 14                           |   |
| 21                       | Radsatz o. Zahnrad o. Haftring AC<br>Wheelset w/o gearwheel w/o tract. tyre     |     | 143946              | 10                           |   |
| 22                       | Radsatz m. Zahnrad m. 2 Haftringe AC<br>Wheelset w. gearwheel w. 2 tract. tyres |     | 143947              | 12                           |   |

Ersatzteile erhalten Sie direkt unter [www.roco.cc](http://www.roco.cc), bei Ihrem Fachhändler oder Ihrer Landesvertretung.  
Spare parts can be ordered directly at [www.roco.cc](http://www.roco.cc) and from your local dealer or country representative.